

DESIGNED BY F.Dino	CHECKED AND APPROVED BY L. Paleari	REVISION	DATE 20/07/2016	CODE I26400
GENERAL TOLLERANCE SS-ISO-2768-1M		UNIT mm	SCALE	SHEET 1 of 2
DESCRIPTION		MATERIAL Stainless steel AISI 304		
DEVICE		PAIR WEIGHT 0,51 Kg	07C	
Property of RAM Industrie. Without its written authorization the present drawing shall neither be used for construction anyway, communicated to third parties, nor reproduced.				

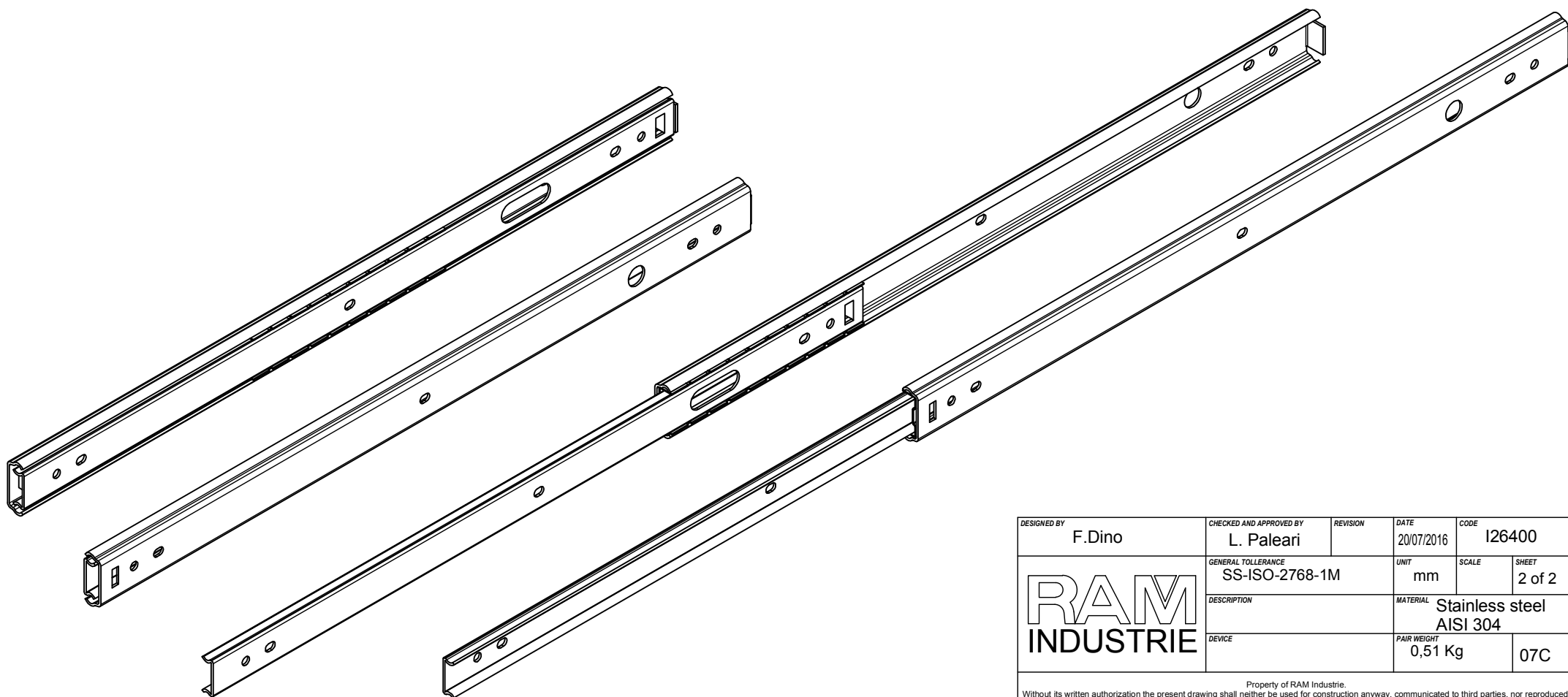
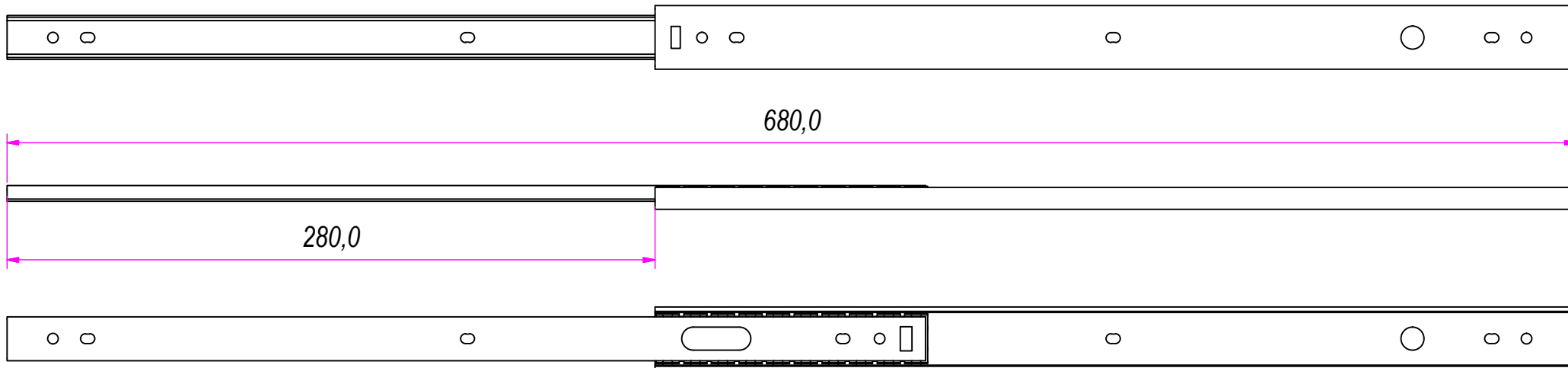

DESIGNED BY F.Dino	CHECKED AND APPROVED BY L. Paleari	REVISION	DATE 20/07/2016	CODE I26400
GENERAL TOLERANCE SS-ISO-2768-1M		UNIT mm	SCALE	SHEET 2 of 2
DESCRIPTION RAM INDUSTRIE			MATERIAL Stainless steel AISI 304	
DEVICE			PAIR WEIGHT 0,51 Kg	07C

Property of RAM Industrie.
Without its written authorization the present drawing shall neither be used for construction anyway, communicated to third parties, nor reproduced.